



**Blue-One disabled pool hoist**





## ***THE PORTABLE POOL LIFT FOR PEOPLE WITH DISABILITIES***

*Our pool lift comes from our skilled experience in the motion and mechanics sector, our strong push for innovative solutions, non-stop research and design in the pool access field.*

*Our company wishes to fill gaps and gives a real hand to those inner needs related to access issues –  
A Free life wherever you are!*



## *INNOVATIVE FEATURES*

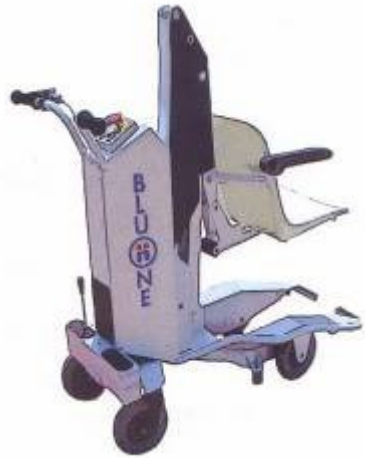

**BLUONE** *is a device to transfer people to and from pools, dressing rooms and other places in an easy, smooth and safe way.*

**BLUONE** *is easy to use. The person is seated on the front seat. You go close to the pool edge or border-line and you stop with the lever –otherwise the device does not work. You start the seat lift-down by pushing the DOWN push-button.*





## *IS EQUIPPED WITH 5 SAFETY LEVELS*

*1 – Key starter and Safety red mushroom.*



*2 – Handbrake. If the handbrake is engaged, the lift-down arm can work.*

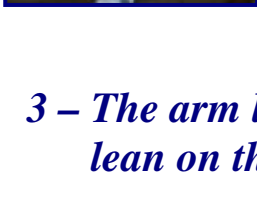

*3 – The arm lifts down and two stainless-steel endings with rubber cover lean on the ground to ensure stability.*



*4 – The lift is equipped with an emergency manual pump.  
Use it in case of Electrical power failure.*

*5 – Rubber stoppers between front and rear wheels to prevent the lift to go in the water.*





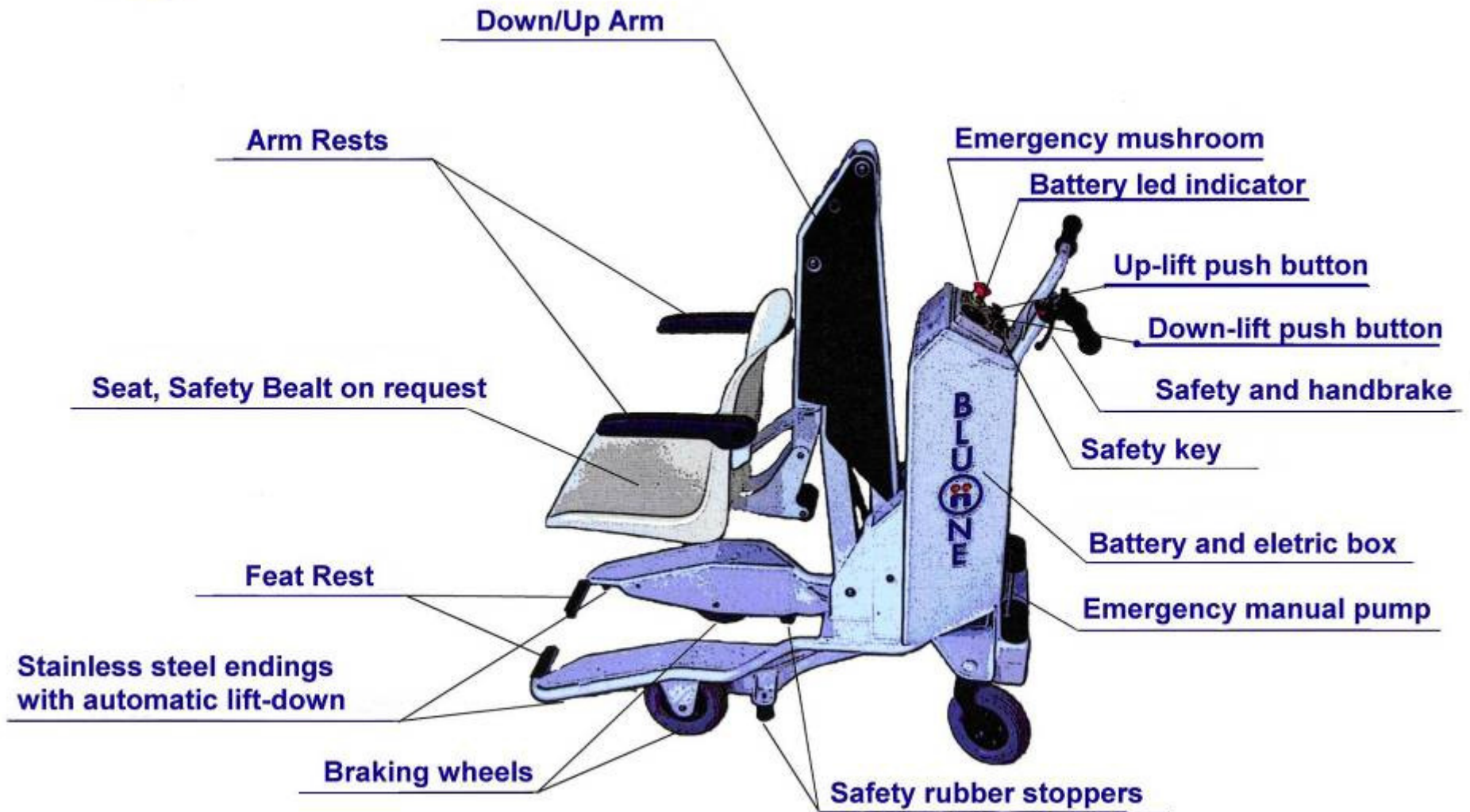

## TECHNICAL SPECIFICATIONS



- *Lifting Capacity: Kgs. 110*
- *Max. arm travel: mms. 1150*
- *Time of down-lifting with weight: sec. 23*
- *Time of up-lifting with weight: sec. 17*



- *Total weight: Kgs. 120*
- *Frame: cold zinc coated steel FE510.*
- *180° powder coating finish*
- *Power: 24 V. battery –battery life: 40 cycles (approx.)*
- *Voltage: 24 V.*
- *Oleodinamic panel*

### OVERALL DIMENSIONS

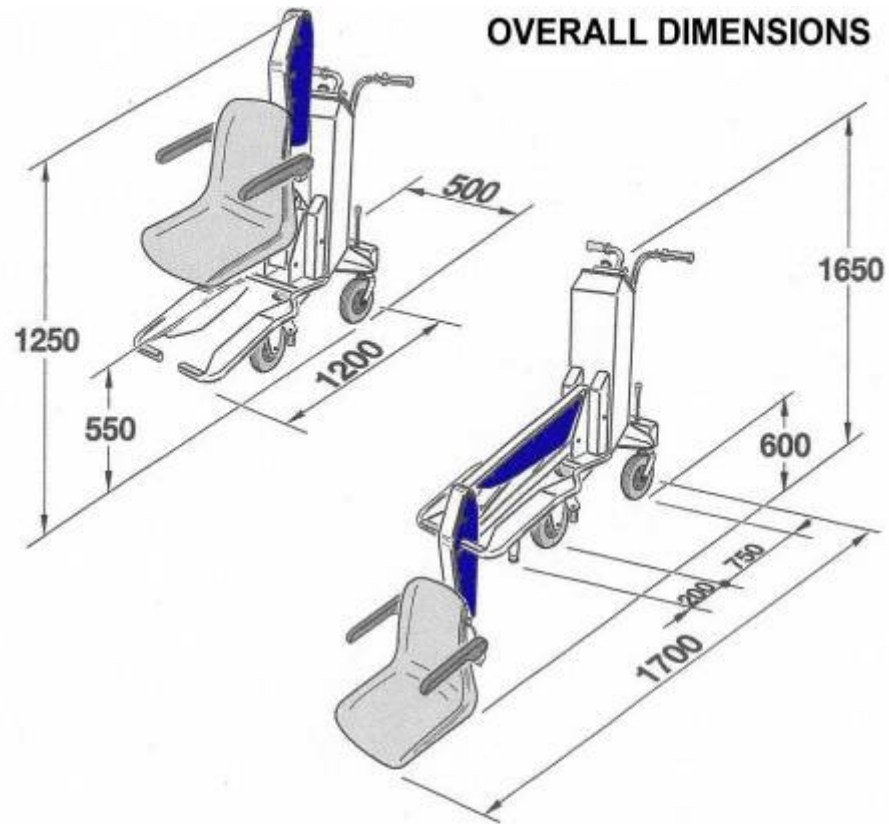

# BLUONE

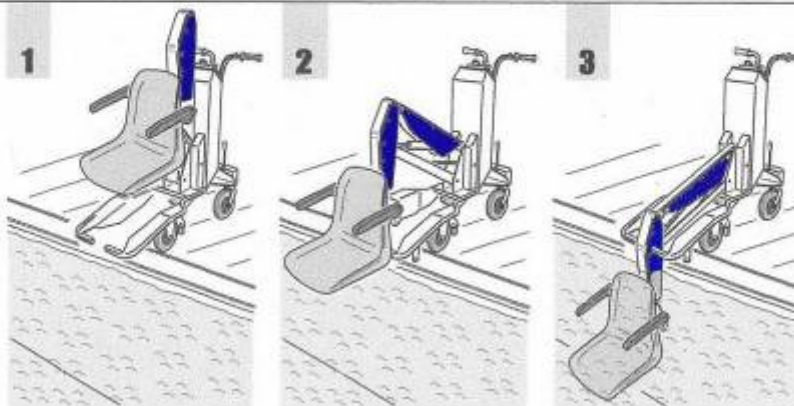
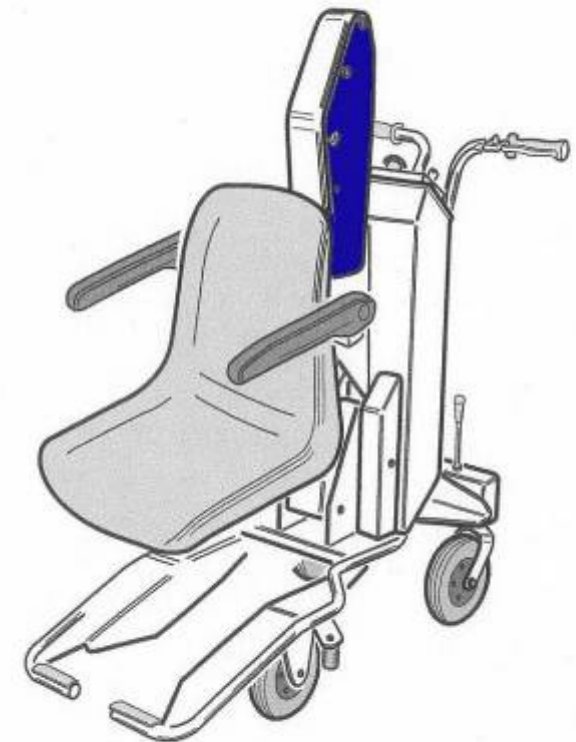

*Made a very easy-to-use portable pool lift. No more stress for people with disabilities, no more uncomfortable slings or wrapping for them. The operator work is smooth and easy, no more dangerous and difficult ways of use.*

**BLU**  **NE** *is a device with **international patent (PCT/IT2006/000014)** –industrial innovation and useful product.*

**BLU**  **NE** *is CE approved and is equipped with an owner's and maintenance manual in accordance with the Device Directive 89/392 and subsequent amendments.*

**BLU**  **NE** *has a warranty of 24 months.*



***ALL THE ABOVE-MENTIONED FEATURES MAKE  
A UNIQUE PORTABLE POOL LIFT.***

**BLU**  **NE**